

Service
Service
Service

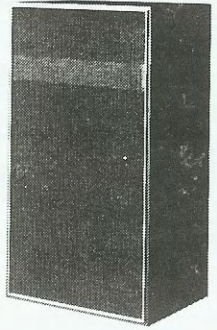

25 litres
295 × 540 × 227 mm.

Service Manual

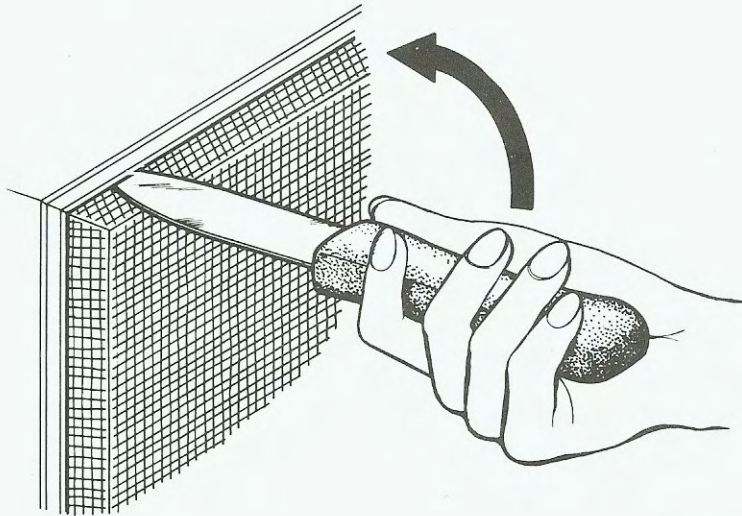

1835A

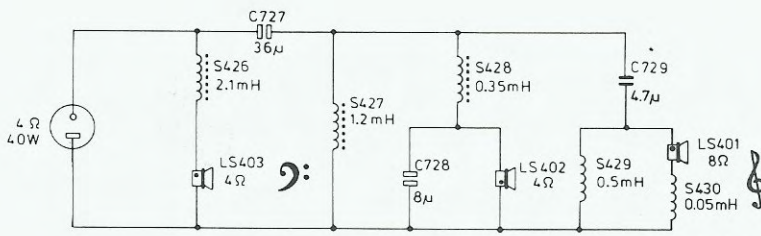

8466A7

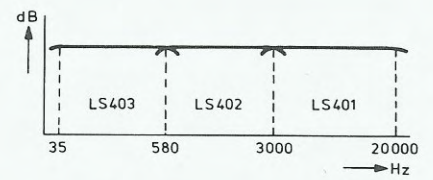

8465A7

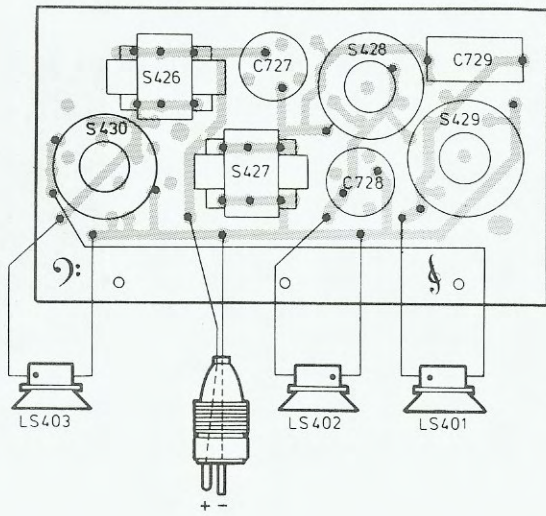

6607A/A

-S-

S426	2.1 mH	4822 152 10084
S427	1.2 mH	4822 152 10083
S428	0.35 mH	4822 157 50595
S429	0.5 mH	4822 152 10075
S430	0.05 mH	4822 157 50817

-C-

C727	36 μ F	4822 124 40077
C728	8 μ F	4822 124 40102

-C-

C729	4.7 μ F	4822 121 40461
------	-------------	----------------

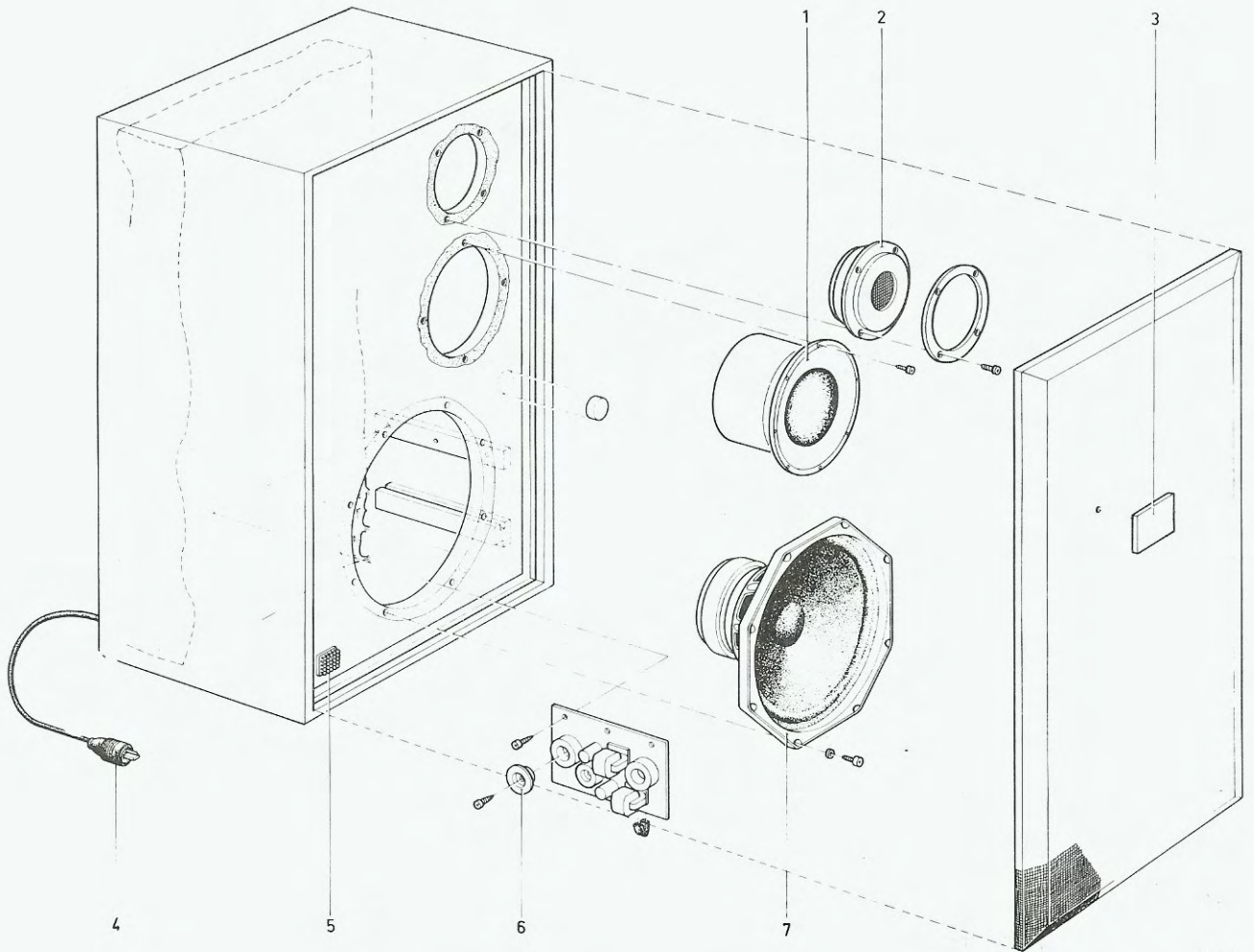

845407

1	LS402	4 Ω	4822 240 50096
2	LS401	8 Ω	4822 240 70009
3			4822 454 10472
4			4822 264 30041
5			4822 426 60055
6			4822 462 70531
7	LS403	4 Ω	4822 240 60064

During production, the print track of the LS-filter has been changed.

The circuit diagram has remained unchanged, with the exception of C729, which becomes 5 μ F - 63 V, code 4822 124 40147. For the modified print layout, see Fig. 1.

Tijdens productie is het printspoor van het L.S. filter gewijzigd.

Het principschema is ongewijzigd gebleven met uitzondering van C729. Deze C729 wordt 5 μ F - 63 V, codenummer 4822 124 40147. Voor de gewijzigde printopstelling zie Fig. 1.

En cours de fabrication, le tracé imprimé du filtre L.S. a été modifié.

Le schéma de principe est inchangé à l'exception de C729 qui passe à 5 μ F - 63 V - code: 4822 124 40147. Voir Fig. 1, disposition modifiée du tracé.

Während der Fertigung ist die Printspur des L.S.-Filters geändert worden.

Das Prinzipschaltbild ist nicht geändert worden (ausgenommen C729). Der Wert von C729 ist nun 5 μ F - 63 V - Code-Nummer 4822 124 40147. Für die geänderte Printanordnung siehe Abb. 1.

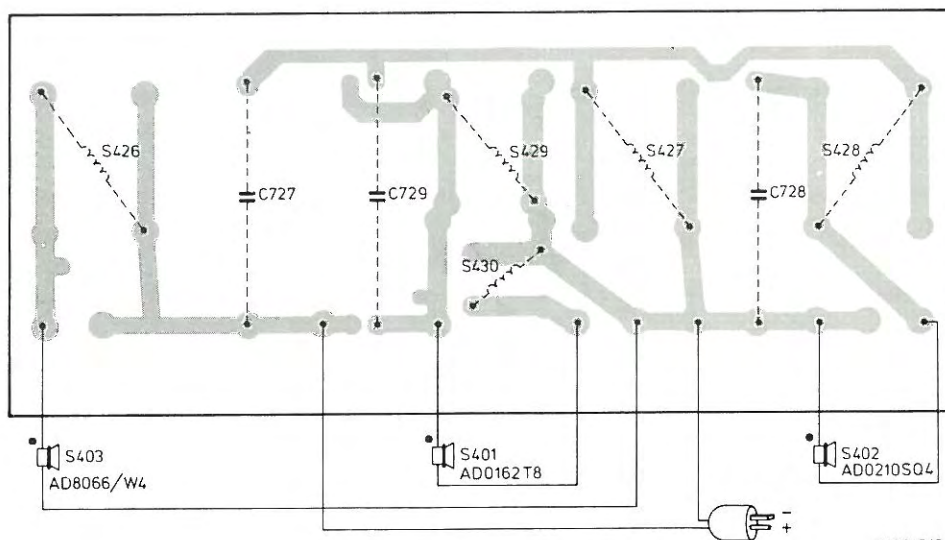

11231B12

Fig. 1